

User's Manual

Drying Ovens / Sterilizers

Models

TS 9026 - TS 9053 - TS 9135 - TS 9430

Basic Functions

This page gives you all information needed to operate the chamber. Details are given on the following pages.

The display backlight turns into power saving mode 30 sec. after last key hit.

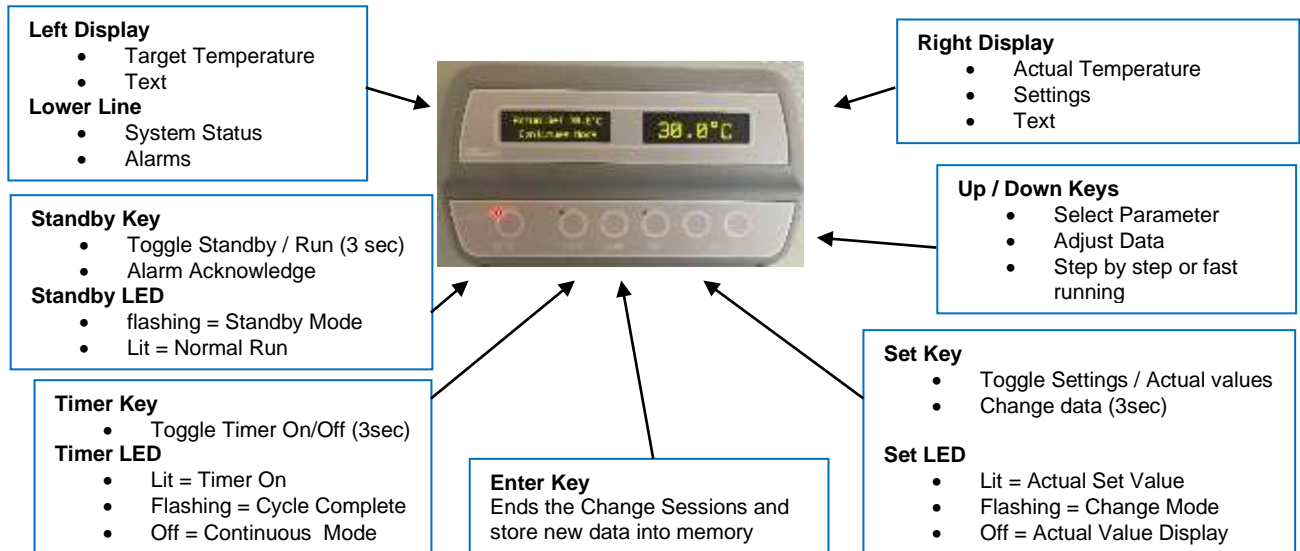

How to Change a Setting

- Go to Display **Settings Mode** by pressing the **Set Key**. Set LED turns on and explaining text appears in left display
- Find desired parameter in the **Settings Menu** with **Down keys**
- Go to **Change Mode** by pressing **Set Key** for 3 sec. LED turns flashing and explaining text appears in left display, Right display will flash
- **Adjust** the setting with **Up/Down Keys**
- **Save** the new setting by pressing the **Enter Key**
-

How to Operate the Standard Timer

- Enter **CycleTime** (hours and minutes) as described above
- **Start** timer by pressing **Timer Key** until the LED turns on
- **Heating Up** is displayed until the Set temperature has been reached
- **Time Left** (Hours Minutes) will be displayed when the set temperature has been reached.

When Cycle is Complete:

- **Cycle Complete** appears in the display
- The LED starts flashing
- Heating turns off
- Air valve closes
- Fan stops (8 minutes delayed)
- The cycle can be **repeated** by pressing **Timer Key** until LED turns on

Installation

- Unpack and place shelves in desired position
- Place the chamber with at least 10 cm free air on all sides
- Do not connect the air outlet to a ventilation system
- Connect the chamber to a grounded power source
- Turn it on with the **Main Switch** on the right side.
- The display turns on and shows **Wait...** for a few seconds
- **Set** the desired **Temperature, Fan Speed, Air Valve** and eventually, the **Time**
- If **Real Time Program** is preferred, choose it in the **System Setup menu**

Main Switch and External Connections

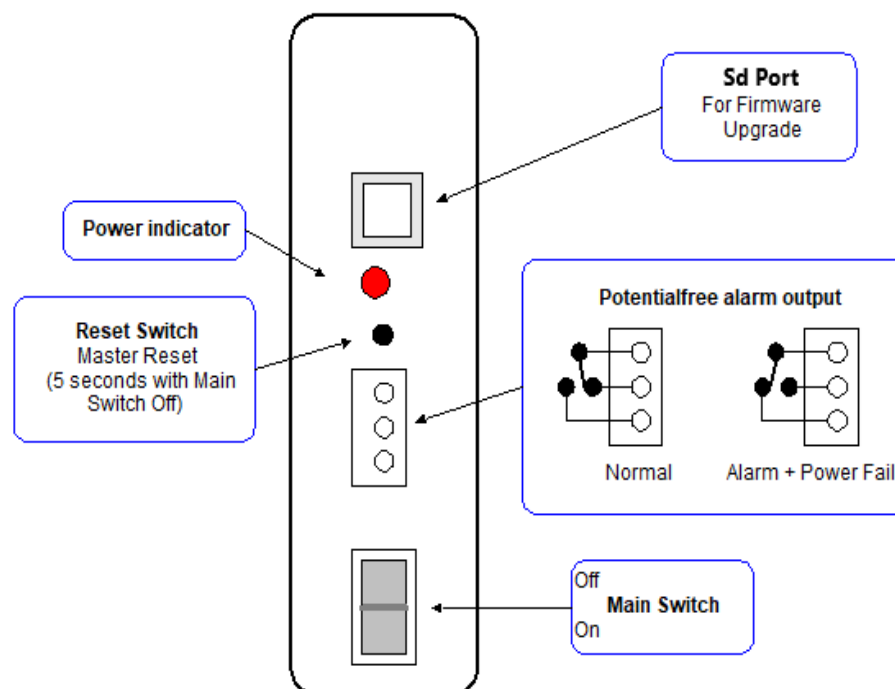

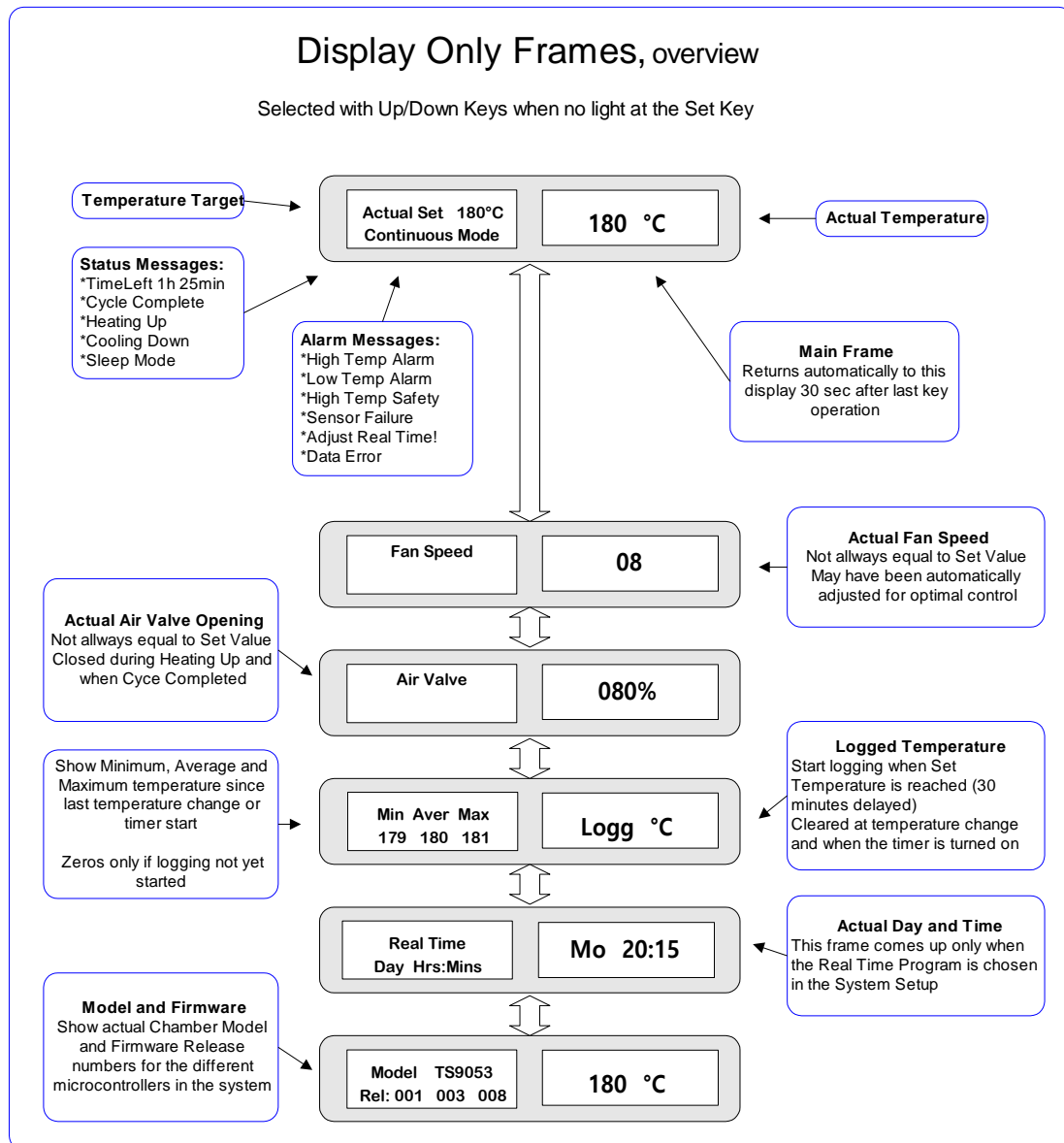

Temperature Logging

- Starts when the temperature has been reached, about 30 minutes delayed
- Used to evaluate the temperature control
- Updates every minute
- Door openings and Air Valve adjustment will affect the Max and Min values
- All zeros means that the logging has not yet started
- Cleared when Power Up, wakeup from Standby, entering new Temperature Set and when turning on the Timer

Settings Menu

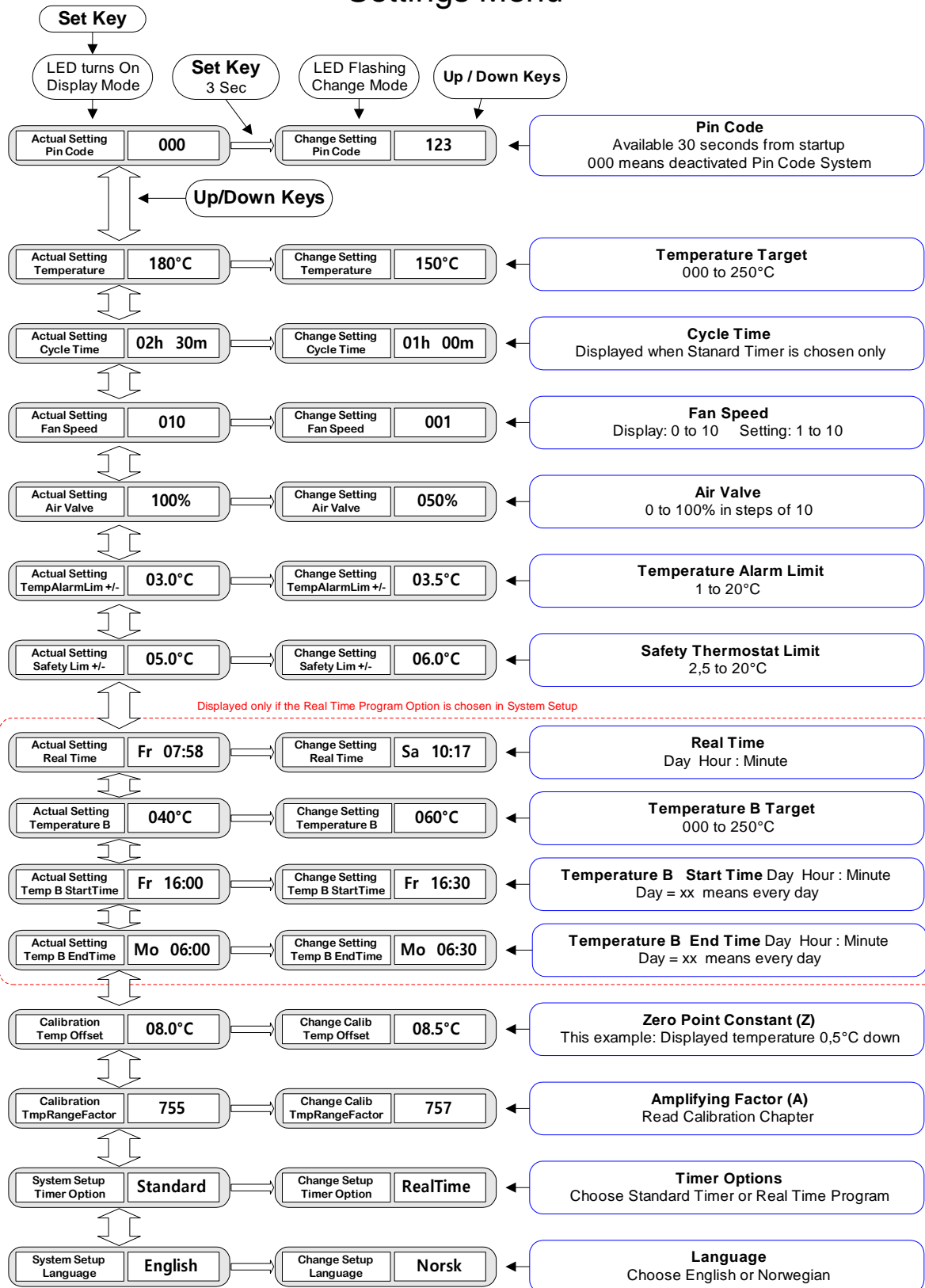

Timers

In the **System Setup**, one of **two timer systems** can be chosen:

Standard Timer (default):

- Can be set to maximum 99 hours and 59 minutes
- Starts counting down when the Set Temperature is reached
- In the case of power failure, lasting more than 5 minutes, the counting will restart from the beginning
- Operation of this timer is described in the chapter **How to Operate the Standard Timer**
- The Fan and Air valve are controlled as illustrated below
- If the chamber shall run without any timing, the time setting should be set to 00h 00m. This will avoid accidental start of the timer

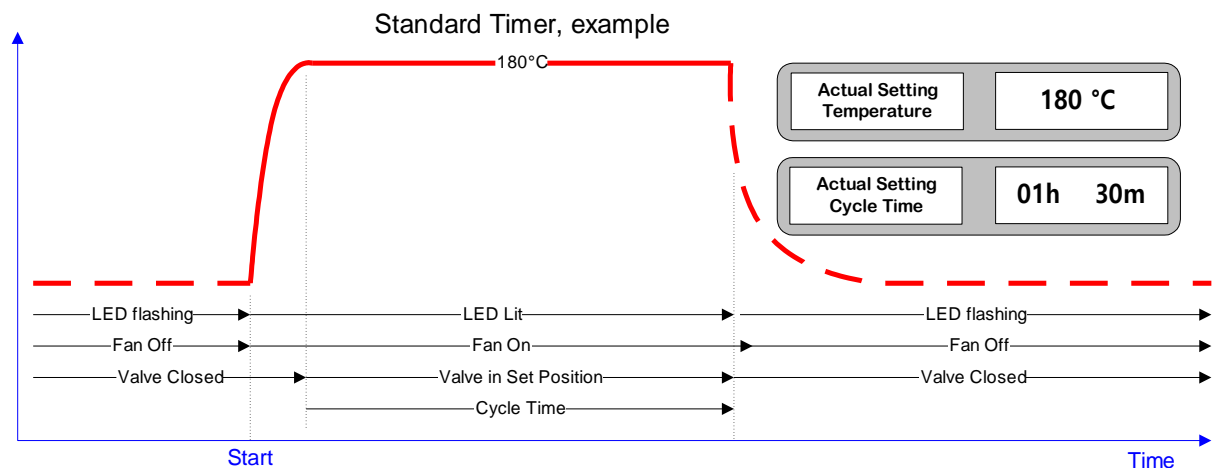

Real Time Program:

- Optional, can be chosen in the System Setup Menu
- Makes it possible to operate the chamber at two different temperatures
- The extra temperature is named **Temperature B** in the menus
- Setting Temperature B to 000°C means that heater and fan are turned off in that period. (Sleep Mode)
- **Start- and end Time** for Temperature B can be set to any time during the **week or on daily basis**
- When choosing **xx** instead of a specified day, the change will occur daily at the given time
- The **Real Time Clock** is backed up for about 10 minutes if power fails. A warning is given if adjustment is needed.

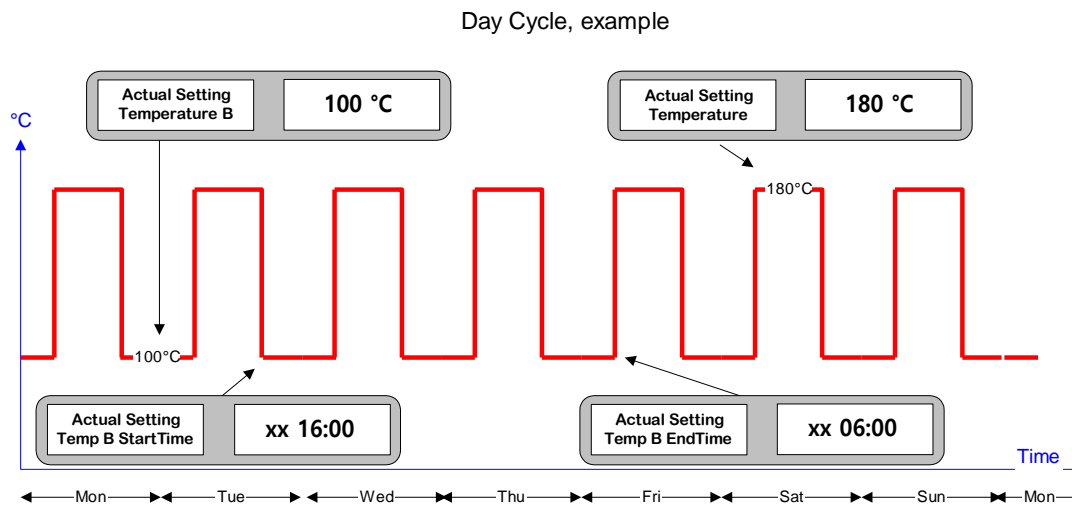
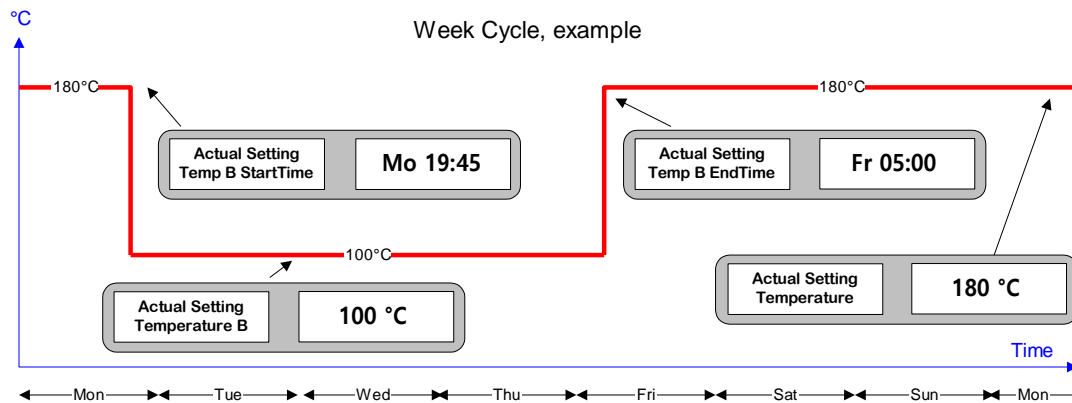

The Fan

- Adjustable speed, 10% to 100%
- When heating up, settings lower than 60% will be ignored
- Stops for about 30 seconds when the door is opened while running at set temperature. This function is disabled for 4 minutes after last door opening or after last Air Valve adjustment
- May reduce speed, or even stop, if operating at a temperature close to the ambient temperature

The Air Valve

- Adjustable opening in steps of 10% (00 = closed, 100 = open)
- Movement may be 10 sec delayed
- Should be open when used for drying purposes
- Closes automatically when heating up, when a timer cycle is completed or in Sleep mode (Real Time Program)

Standby

- Preferred way to shut down the chamber. Keeps the real time clock running
- Turns off Heaters, Fan and Display
- Press the Standby Key for about 3 seconds until the backlight in the display turns off
- The Standby LED will start flashing when the key is released.
- The chamber can be restarted by pressing the Standby Key for 3 seconds
- The right display will show Wait... for a moment during initialization

Pin Code

- Optional system to stop unwanted settings from unauthorized persons
- A **personal pin code** can be entered during the first 30 seconds after turning the chamber on with the main switch or waking up from Standby Mode. Actual code is displayed after pressing the Set key in that period. A unique code can be chosen in the range from 001 to 999.
- 000 means deactivated Pin Code System.
- When activated, **Pin Code?** will be displayed in the left display.
- **Actual code must be set by Up/Down Keys**, followed by pressing the **Enter Key**
- The system will remain opened for 30 seconds after the last key operation.
- Alarms can be acknowledged by the Standby Key even if the keys are locked

Alarms

- A number of alarm situations may occur, listed below
- Actual warning is given in the lower line of the left display
- The backlight starts flashing and the buzzer starts sounding whenever an alarm occur
- The flashing and the sound can be stopped by pressing the Standby Key

Displayed Warning Left Display	Explanation	
High Temp Alarm	The temperature has drifted above the entered High Temperature Alarm Limit Turns off 0,5°C below the Alarm Limit	Disabled during: Change Up/ Down, Cycle Complete and Sleep Mode Disabled for 4 minutes after: <ul style="list-style-type: none"> • Door Opening • Valve Adjustment • Heating Up • Cooling Down
Low Temp Alarm	The temperature has dropped below the entered High Temperature Alarm Limit Turns off 0,5°C above the Alarm Limit	
High Temp Safety	The Temperature Safety Limit has been exceeded and the power to the heater is shut off	
Sensor Failure	One of the two sensors, for display or safety, is probably broken. The chamber operates with limited safety	
Adjust Real Time!	The Real Time Clock needs adjustment. Probably due to a significant power failure	
Data Error	Communication error between the panel and the controller. The chamber operates with the last valid settings, but the displayed data may be wrong	

Alarm Output

- A potential free contact is available for external use (see drawing Main Switch and External Connections)
- The output switches when an alarm situation occurs, one minute delayed
- Switches immediately at power failure
- Immediate return to normal when the alarm situation is over

Schedul/Ramping

There can be up to **5 schedules**. A new schedul consists of following

- A start block
- Start day (All, Mon-Sun, None)
- Start hour (0-23)
- Start minute (0-59)
- End mode (Stop, Continue, Cycle, Standby)

You can have up to 10 temp blocks in every scheduler.

- In every block you choose 3 different parameters
- Run time before shift (hours) (0-100, 0=block disabled)
- Temperature (0,0 to 250)
- Ramp °c/hour (1,0 – 60)

Ex. Of scheduler 1.

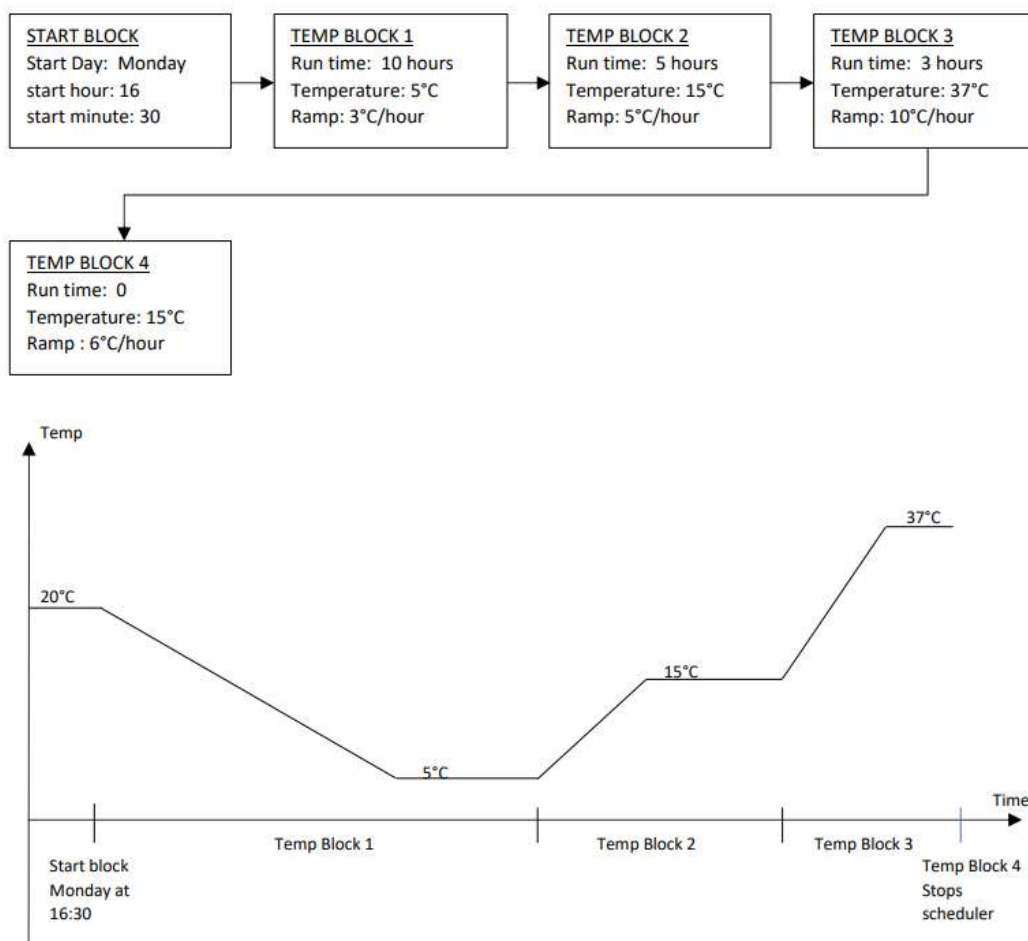

- Here you have all 5 different schedules.
- You can set up all 5 differently and then chose which one you want to use.

Schedule 1	Schedule 2	Schedule 3	Schedule 4	Schedule 5
Start day	Start day	Start day	Start day	Start day
Start hour	Start hour	Start hour	Start hour	Start hour
Start minute	Start minute	Start minute	Start minute	Start minute
Block 1 Run time Temp Ramp	Block 1 Run time Temp Ramp	Block 1 Run time Temp Ramp	Block 1 Run time Temp Ramp	Block 1 Run time Temp Ramp
Block 2 Run time Temp Ramp	Block 2 Run time Temp Ramp	Block 2 Run time Temp Ramp	Block 2 Run time Temp Ramp	Block 2 Run time Temp Ramp
Block 3 Run time Temp Ramp	Block 3 Run time Temp Ramp	Block 3 Run time Temp Ramp	Block 3 Run time Temp Ramp	Block 3 Run time Temp Ramp
Block 4 Run time Temp Ramp	Block 4 Run time Temp Ramp	Block 4 Run time Temp Ramp	Block 4 Run time Temp Ramp	Block 4 Run time Temp Ramp
Block 5 Run time Temp Ramp	Block 5 Run time Temp Ramp	Block 5 Run time Temp Ramp	Block 5 Run time Temp Ramp	Block 5 Run time Temp Ramp
Block 6 Run time Temp Ramp	Block 6 Run time Temp Ramp	Block 6 Run time Temp Ramp	Block 6 Run time Temp Ramp	Block 6 Run time Temp Ramp
It goes up to 10	It goes up to 10	It goes up to 10	It goes up to 10	It goes up to 10

Sc

Schedule/Ramping explained in pictures.



Here you have what the display show when the Schedule/ramping is activated.

On this page you choose which Schedule you want You can have 5 different Schedules.

Remember that you have 5 different Schedules, every schedule can be set differently, here you choose which one you want.

On this page you choose which day you want to start on you can chose between mon-sun, all days or none.

On this page you choose which hour of the day you want it to start on.

On this page you choose which minute of the hour you want it to start on, Choose 0 if you want just the hour.

Here you can choose what the cabinet should do after the schedule/ramping is done.

This setting has nothing to do with the block parameters, this setting only decide what the cabinet does after the scheduler is done.

This page shows you how to set the block parameters



Here you choose which block you want to set, you can choose between 10 blocks, when you change block, you will need to change all the parameters shown below.

Remember that you will need to set all blocks up like you want them. Every block you want to use need to be set up like shown below.



On this page you choose how many hours you want the block to run. If you do not want the block to run, you choose 0 as run time.



On this page you choose the temperature you want the block to be set on.



On this page you choose the ramping of the temperature. Ramping means how many degrees the cabinet will go up or down in an hour.

- When all these steps are done do not forgett to press and hold button **Cycle** for 3 sec otherwise the Schedule will not start.
- You will also need to set the clock to the right time in the real time program menu otherwise it will not start on the right time.
- The Schedule will now start at the choosen time.

Sterilization Cycle:

- A **fixed sterilization cycle** for the chamber is available, 180°C in 40 minutes.
- Enter the **“Timer Option”** menu under Setup and select Sterilization Cycle **“Steriliz”**
- Sterilization Cycle behaves as Standard Timer, but temperature and time can't be adjusted.
- The Sterilization Cycle can be **started** pressing the **“Cycle”** - key for 3 seconds.
- The message **“Sterilization”** appears in the left display and the Cycle LED turns on.
- **“Heating Up”** is displayed until the temperature **180°C** has been reached.
- **“Time left”** will be displayed when the temperature **180°C** has been reached.
- When finished, **“Sterilize Complete”** will be displayed, the cycle LED will flash and the buzzer will buzz shortly.
- To return to normal operation
 - Press the **“Cycle”** key shortly to enter continuous mode.
 - Press the **“Power”** key for 3 second to turn off.
 - Press the **“Cycle”** key for 3 seconds to start a **“Standard timer”** cycle.

Note when the Sterilization cycle is done the **“Timer Option”** is automatically set to **“Standard timer”**,

so to start a new Sterilization cycle the user must set the **“Timer Option”** to sterilization cycle again.

This is done to prevent an accidently start of the **“Sterilization cycle”**

Safety Thermostat

- Automatic system, preventing risky temperatures in the case of a controller failure
- Completely independent from the ordinary temperature control system
- Automatically adjusted whenever a new Temperature Set is entered
- Adjustable limit (offset from target)
- Cuts power to the heaters when the limit is exceeded
- Generates an alarm warning
- Turns to normal when the temperature has dropped 0,5°C below the limit

Calibration

Two calibration constants can be adjusted in order to bring the temperature measurement equal to the true value according to a control device:

Amplifying Factor (A)

Should be calculated if the chamber is used in a wide temperature range

Zero Point Constant (Z)

Should be calculated if display and a control device is not equal at normal working temperature

The calibration should be performed as follows:

Place the control device (external temp device) into the middle of the cabinet and let the cabinet stabilize at a low temperature
Note the displayed temperature, T_{dl} and the true temperature measured in the control device T_{cl} .

Example:

$$T_{dl} = 50^{\circ}\text{C} - T_{cl} = 50,8^{\circ}\text{C}$$

Let the cabinet stabilize at a high temperature
Note the displayed temperature, T_{dh} and the true temperature measured in the control device T_{ch}

$$T_{dh} = 180^{\circ}\text{C} - T_{ch} = 181,5^{\circ}\text{C}$$

Find current amplifying factor in the Settings Menu

$$A = 1,000$$

Calculate the new factor:

$$A_{\text{new}} = \{(T_{ch} - T_{cl}) / (T_{dh} - T_{dl})\} * A$$

Enter A_{new}

$$A_{\text{new}} = \{(181,5 - 50,8) / (180 - 50)\} * 1,000 = 1,005$$

Let the cabinet stabilize at a temperature in the middle of the normal working range

Note the displayed temperature T_d and the true temperature measured in the control device T_c

$$T_d = 120^{\circ}\text{C} - T_c = 122,0^{\circ}\text{C}$$

Find current zero point constant in the Settings Menu

$$Z = 0,00$$

Calculate the new constant:

$$Z_{\text{new}} = Z + T_d - T_c$$

Enter Z_{new}

$$Z_{\text{new}} = 0,00 + 120 - 122,0 = -2$$

The chamber is 2 degrees hotter then then it should be, so then you have to go to temp offset and raise the chamber with 2 degrees. If the new Z is – you raise the temp if it is + you lower the temp

Grunnfunksjoner

Denne siden viser det som trengs for å betjene skapet. Funksjonene er beskrevet mer i detalj på de følgende sidene.

Bakgrunnslyset i displayet går i sparemodus 30 sekunder etter siste knappetrykk

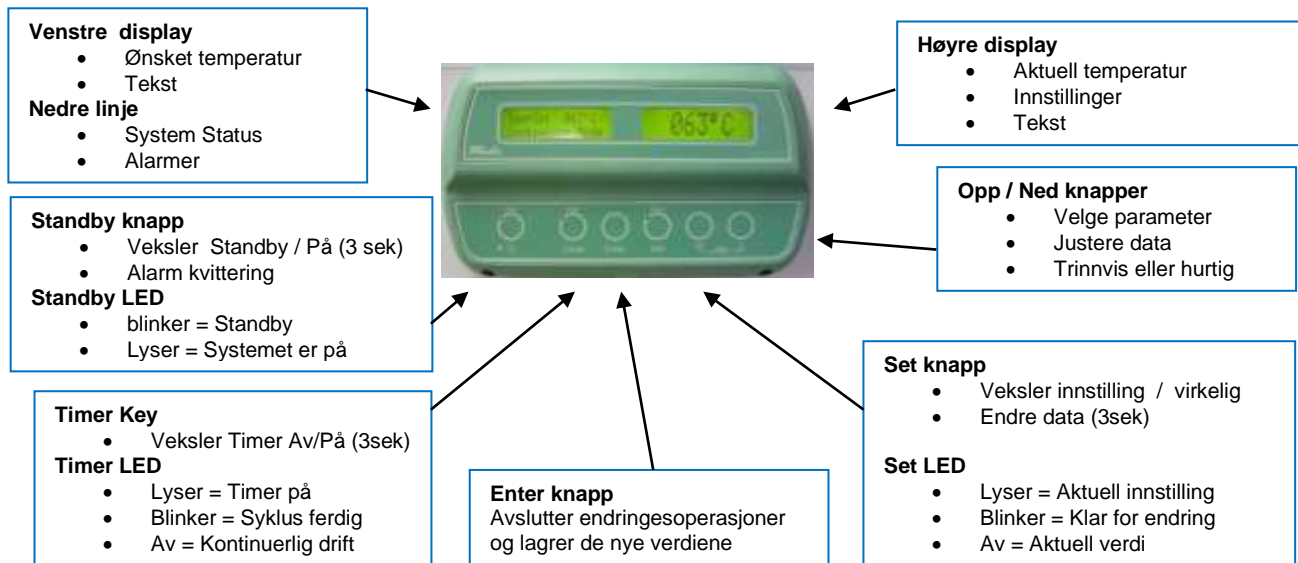

Hvordan endre en innstilling

- Vis aktuelle innstillinger med et lett trykk på **Set**-knappen. **Set LED** lyser opp og forklarende tekst kommer i venstre display
- Velg ønsket parameter i innstillingsmenyen med **Ned** -knappene
- Gå til endringsmodus ved å holde **Set**-knappen inn i 3 sekunder. LED begynner å blinke og forklarende tekst kommer i venstre display, høyre display vil blinke
- Juster med **Opp / Ned** -knappene
- Lagre endringen med et lett trykk på **Enter**-knappen

Hvordan bruke standard timer

- Mat inn ønsket tid som beskrevet over
- Aktiver timeren ved å holde **Timer**-knappen inn i 3 sekunder til LED lyser
- **Varmer opp** vises inntil innstilt temperatur er oppnådd
- Når ønsket temperatur er oppnådd, vises gjenværende tid i timer og minutter

Ved fullført tid:

- **Syklus ferdig** vises i displayet
- LED blinker
- Varmeelementene slås av
- Spjeldet lukker
- Viften stopper (8 minutter forsinket)
- Syklusen repeteres ved å holde **Timer**-knappen inn i 3 sekunder til LED lyser

Innstallasjon

- Pakk ut og plasser hyllene i ønsket posisjon
- Plasser skapet med minst 10 cm luft på alle sider
- Spjeldåpningen skal ikke knyttes direkte til eksternt ventilasjonsanlegg
- Sett støpselet i en jordet stikkontakt
- Slå på skapet med hovedbryteren på høyre side, bak
- Displayet vil vise Wait.. i noen sekunder, deretter målt temperatur
- Innstill ønsket temperatur, viftehastighet, spjeldåpning og eventuelt tid
- Hvis norsk tekst ønskes i displayet, gå til System Setup og endre språk
- Programverk kan velges i stedet for standard timer i Systeminnstilling

Hovedbryter og tilkoblinger

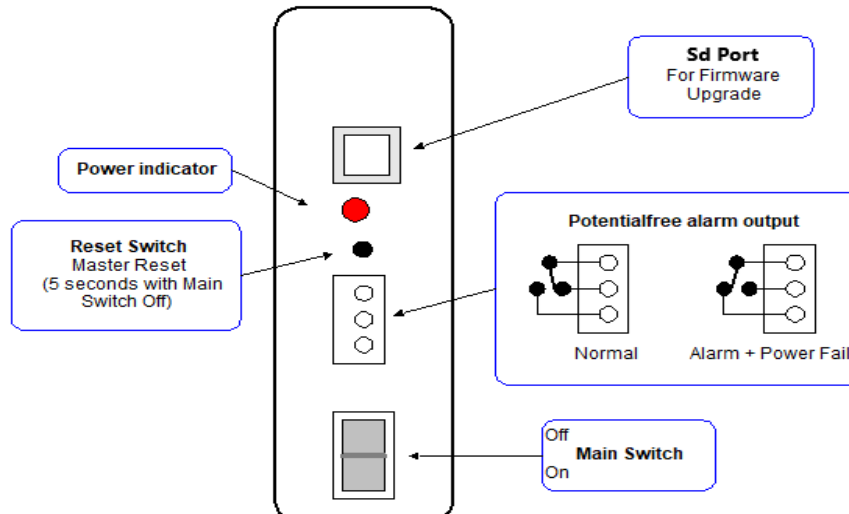

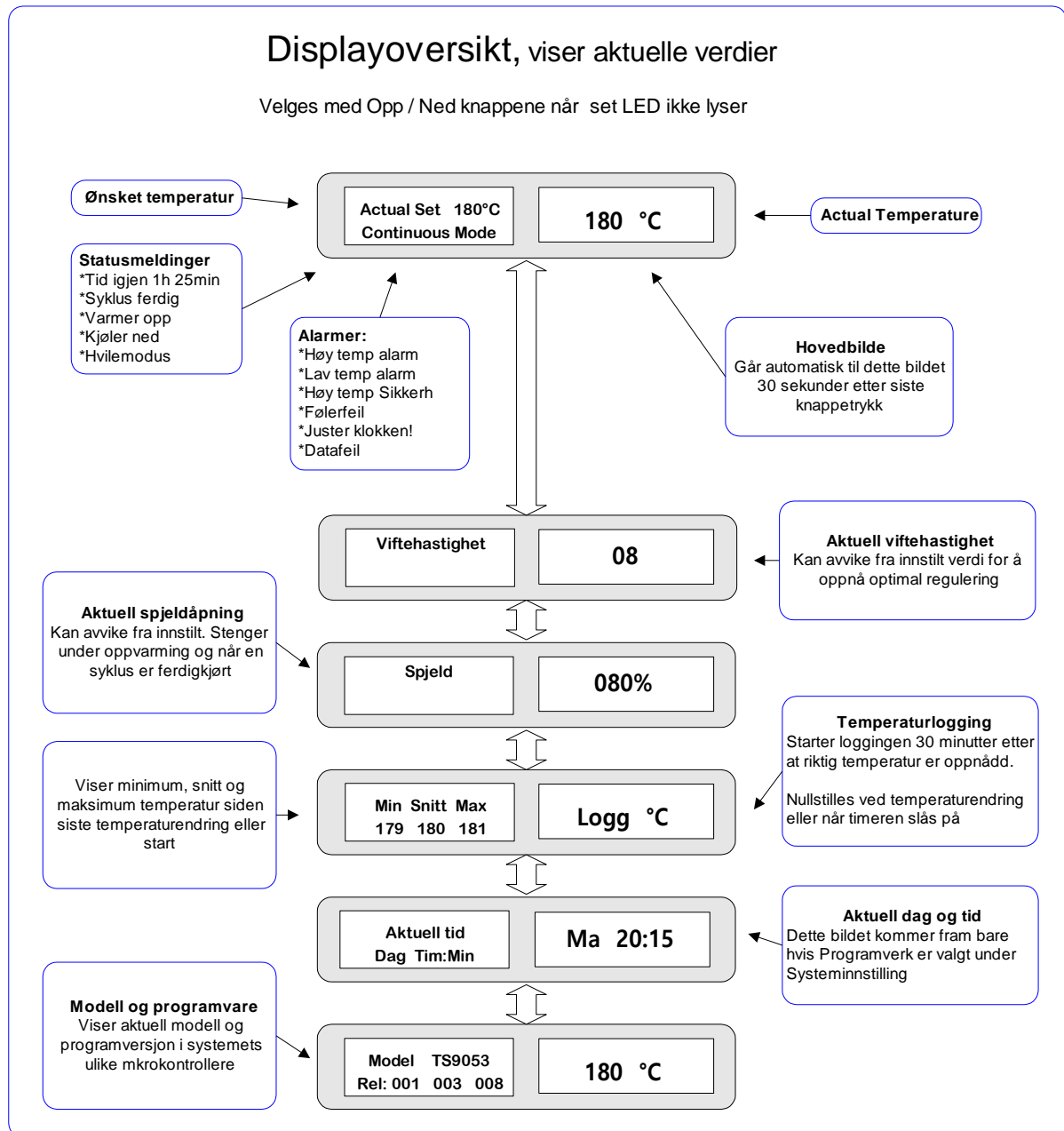

Temperaturlogging

- Starter når innstilt temperatur er oppnådd, ca 30 minutter forsinket
- Brukes til å evaluere temperaturreguleringen
- Oppdateres hvert minutt
- Døråpninger og spjeldendringer påvirker resultatet
- 000 betyr at logging ikke har startet
- Nullstilles når skapet slås på med hovedbryter eller etter Standby, når ny temperatur innstilles eller når timeren slås på

Innstillingsmeny

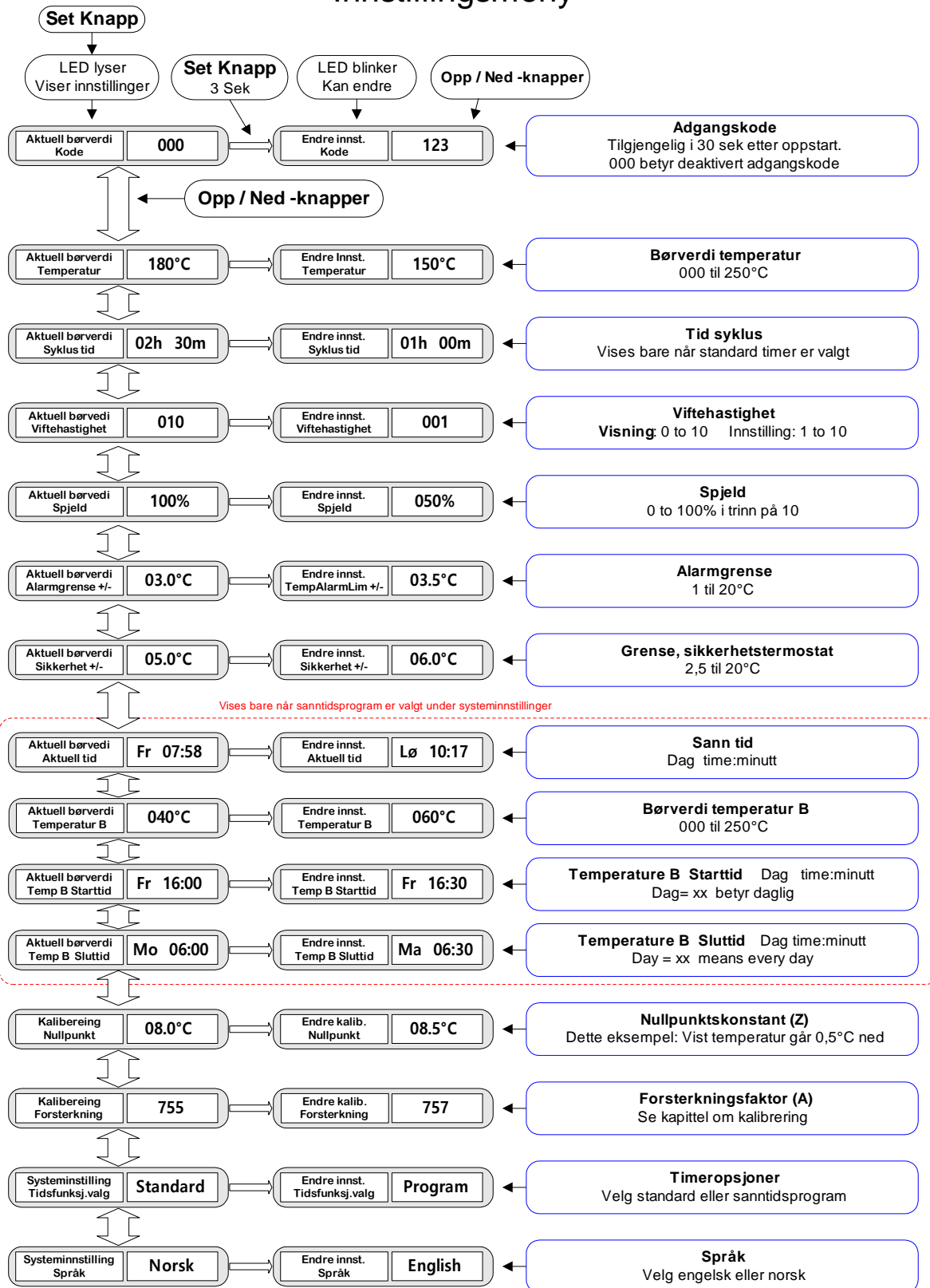

Timere

En av to tidsfunksjoner kan velges under **Systeminnstillinger**

Standard (fra fabrikk):

- Kan innstilles til maksimum 99 timer og 59 minutter
- Begynner å telle ned tiden når ønsket temperatur er oppnådd
- Ved et eventuelt strømbrudd som varer mer enn 5 minutter, vil nedtellingen starte fra full tid når strømmen er kommet tilbake
- Se kapittelet **Hvordan bruke standard timer**
- Vifte og spjeld blir styrt som illustrert nedenfor
- Hvis timeren ikke skal benyttes, anbefales det å sette tiden til 00h:00m. Dette hindrer at timeren blir satt på utilsiktet

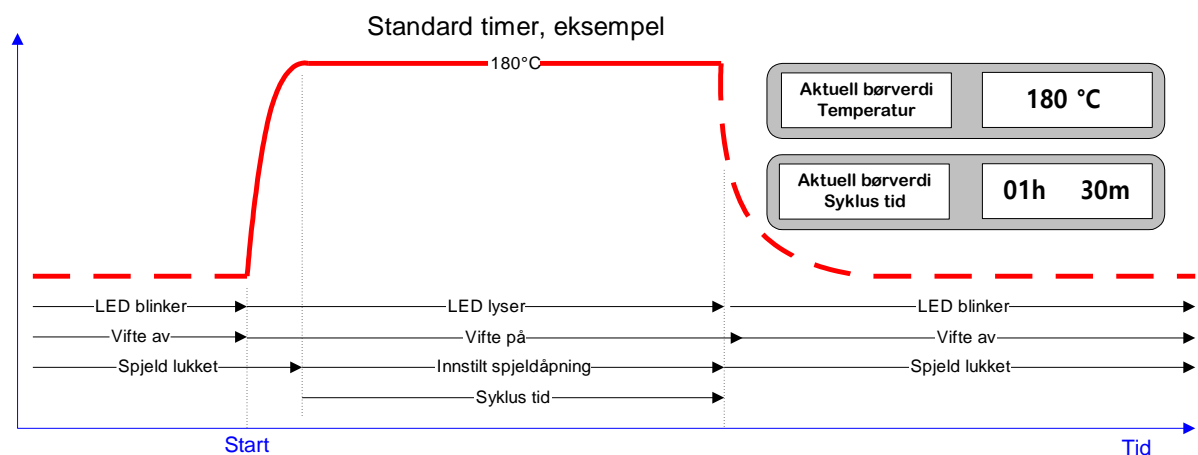

Sanntidsprogram:

- Alternativ som kan velges under **Systeminnstilling**
- Gjør det mulig å veksle mellom to temperaturer på angitte tidspunkt
- Den ekstra bærverdien kalles Temperatur B i menyene
- Når temperature B settes til 000°C, betyr det at vifte og varmeelementer stopper i den perioden (Hvilemodus)
- Start- og sluttid for temperatur B kan settes til ethvert tidspunkt i løpet av uken eller på daglig basis
- Velges **xx** i stedet for ukedag, kommer endringene daglig til angitt tidspunkt
- Klokken holdes i gang i 10 minutter ved et eventuelt strømbrudd. Varsling kommer i displayet hvis klokken må stilles

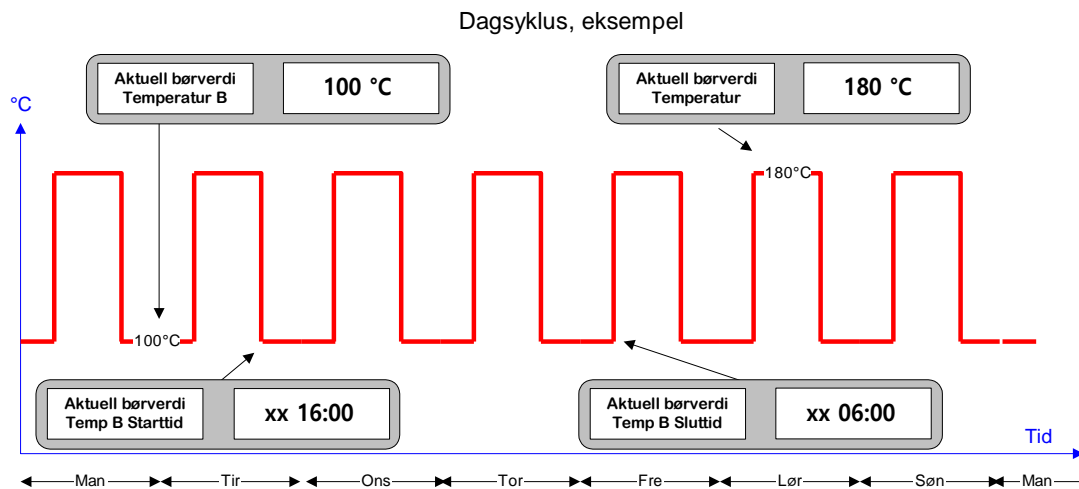
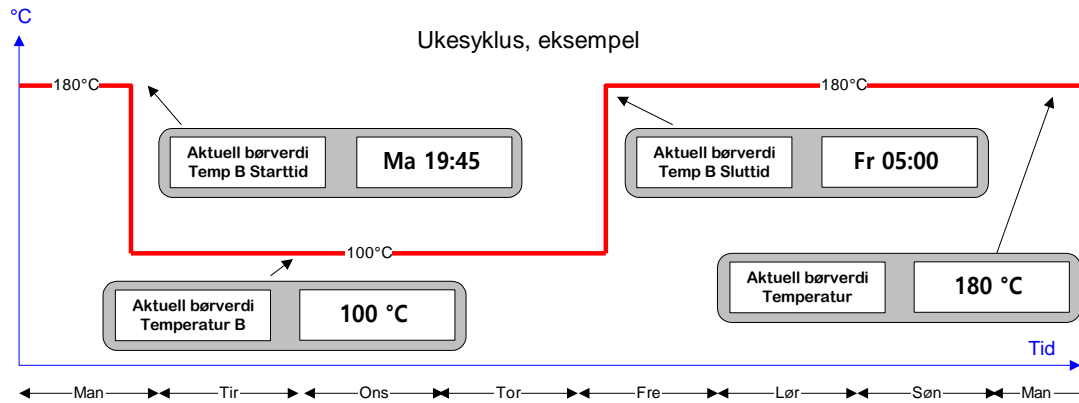

Viften

- Justerbar hastighet, 10% til 100%
- Under oppvarming vil hastigheter lavere enn 60% bli ignorert
- Stopper i ca 30 sekunder n r d ren  pnes etter at riktig temperatur er oppn dd. Denne funksjonen sperres i 4 minutter etter forrige d r pning og etter at spjeld pningen er justert
- Viftehastigheten kan automatisk bli redusert eller stoppe hvis arbeidstemperaturen ligger n r v relsestemperaturen

Spjeldet

- Justerbar  pning i trinn p  10% (000 = Lukket, 100 =  pen)
- Endring kan v re opptil 10 sekunder forsinket
- Skal v re  pen n r noe skal t rkes, men lukket ved sterilisering av t rre ting
- Lukker automatisk under oppvarming, n r en syklus er fullf rt eller i hvilemodus (Sanntidsprogram)

Standby

- Anbefalt m te   sl  av skapet. Holder klokken i gang.
- Sl r av varmeelementer, vifte og display
- Hold **Standby**-knappen inne i 3 sekunder til display slukker
- Standby LED tenner n r knappen slippes
- Skapet startes igjen ved   holde knappen inne i nye 3 sekunder.
- H yre display vil vise **Wait..** under oppstartsprosedyren

Adgangskode

- Kan brukes for å hindre andre personer i å gjøre endringer
- En personlig kode kan velges i løpet av de første 30 sekundene etter at skapet er slått på. Aktuell kode vises etter et trykk på **Set**-knappen i denne perioden. Ny kode kan velges i området 001 til 999
- Kode 000 betyr at kodesystemet er avslått
- Når systemet er aktivert vil **Kode?** bli vist i venstre display
- Valgt kode må da settes inn med **Opp / Ned** –knappene, etterfulgt av et trykk på **Enter**-knappen
- Systemet forblir åpent i 30 sekunder etter siste knappetrykk
- Alarmer kan kvitteres ut selv om systemet er låst

Alarmer

- Nedenfor er det listet opp mulige alarmsituasjoner
- Alarmene vises alltid i venstre display, nedre linje
- Bakgrunnslyset blinker og en akustisk alarm høres når en alarmsituasjon oppstår
- Blinkingen og lyden kan slås av med et lett trykk på **Standby**-knappen

Melding i venstre display	Forklaring	
Høy temp alarm	Temperaturen har kommet over innstilt grenseverdi for alarm Slår av igjen når temperaturen har kommet 0,5°C under grenseverdien	Deaktivert mens: Endring opp eller ned, syklus fullført eller i hvilemodus Deaktivert I 4 minutter etter: <ul style="list-style-type: none"> • Døråpning • Spjeldjustering • Oppvarming • Nedkjøling
Lav temp alarm	Temperaturen har kommet under innstilt grenseverdi for alarm Slår av igjen når temperaturen har kommet 0,5°C over grenseverdien	
Høy temp sikkerh	Sikkerhetsgrensen har blitt overskredet og strømmen til varmeelementene brytes	
Følerfeil	Trolig brudd i en av de to temperaturløerne. Skapet fortsetter å arbeide, men med redusert sikkerhet	
Juster klokken!	Sanntidsklokken trenger justering på grunn av et strømbrudd med varighet på flere minutter	
Datafeil	Kommunikasjonsproblem mellom panel og regulator. Skapet arbeider trolig fortsatt, men dataene i displayet kan være feil	

Alarmutgang

- En potensialfri kontakt er tilgjengelig for eksternt bruk (se skisse **Hovedbryter og tilkoblinger**)
- Kontakten veksler når en alarmsituasjon oppstår, ett minutt forsinket
- Veksler umiddelbart ved spenningsbortfall
- Returnerer til normalposisjon når alarmtilstanden opphører

Sikkerhetstermostaten

- Et automatisk system som hindrer ødeleggende temperaturer hvis regulatoren svikter
- Separat system, helt uavhengig av regulatoren
- Justeres automatisk når en ny børverdi mates inn
- Justerbar grense (avvik fra børverdi)
- Bryter strømmen til varmeelementene når grensen overskrides
- Utløser et alarmvarsel
- Går tilbake til normal når temperaturen har kommet 0,5°C under grensen

Kalibrering

To konstanter kan justeres for å få vist temperatur i displayet til å stemme med et eksternt kontrollinstrument:

Forsterkningsfaktor (A)

Bør beregnes når skapet anvendes over et større temperaturområde

Nullpunkt (Z)

Bør beregnes når det er avvik mellom display og kontrollinstrument ved normal arbeidstemperatur

Kalibreringen bør utføres på følgende måte:

Plasser kontrollinstrumentet i midten av skapet og la det stabilisere på en lav temperatur
Noter displaytemperaturen, T_{dl} , og kontrollinstrumentets temperatur, T_{cl} .

Eksempel:

$$T_{dl} = 50^{\circ}\text{C} - T_{cl} = 50,8^{\circ}\text{C}$$

La skapet stabilisere på en høy temperatur
Noter displaytemperaturen, T_{dh} , og kontrollinstrumentets temperatur, T_{ch}

$$T_{dh} = 180^{\circ}\text{C} - T_{ch} = 181,5^{\circ}\text{C}$$

Finn gjeldene forsterkningsfaktor i innstillingsmenyen

$$A = 1,000$$

Beregn ny faktor:

$$A_{\text{new}} = \{(T_{ch} - T_{cl}) / (T_{dh} - T_{dl})\} * A$$

Mat inn A_{new}

$$A_{\text{new}} = \{(181,5 - 50,8) / (180 - 50)\} * 1,000 = 1,005$$

La skapet stabilisere i midten av det aktuelle arbeidsområdet
Noter displaytemperaturen, T_d , og kontrollinstrumentets temperatur, T_c

$$T_d = 120^{\circ}\text{C} \quad T_c = 122,0^{\circ}\text{C}$$

Finn gjeldene nullpunktskonstant i innstillingsmenyen

Beregn ny konstant:

$$Z_{\text{new}} = Z + T_d - T_c$$

Mat inn Z_{new}

$$Z = 0,00$$

$$Z_{\text{new}} = 0,00 + 120 - 122,0 = -2$$

Kammeret er 2 grader varmere så da skal det være, så da må du gå til temp offset og heve kammeret med 2 grader. Hvis den nye Z er - øker du temp hvis det er + senker du temp